

LV/LV TRANSFORMERS

TECHNICAL
GUIDE

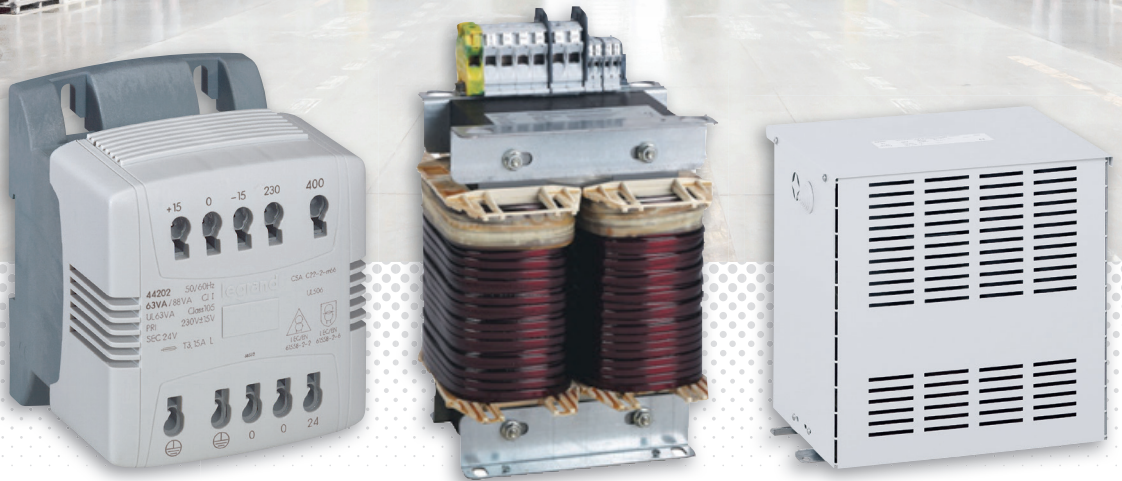

The first transformer application came about because of the need to change voltage in AC supplies. The second consists of isolating circuits in order to protect people and property.

Nowadays, industrial and commercial environments, as well as domestic environments, offer a huge range of applications requiring the development of all types of transformer, in very extensive power ranges.

The products always have a seemingly simple appearance, and all look similar: it is therefore important to understand the different types and associated characteristics in order to make the right choice.

This guide covers transformers for control applications, and equipment used in control and automation enclosures or in enclosures dedicated to one item of equipment,

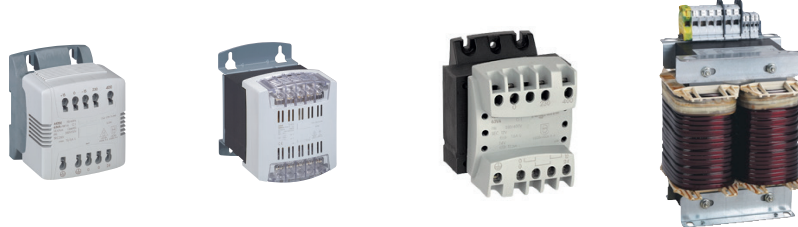

and also low-voltage installation transformers used as an interface in LV distribution networks in industry and services.

LEGAL INFORMATION

In accordance with its policy of continual improvement, the Company reserves the right to modify specifications and drawings without prior notice. All the illustrations, descriptions and technical data contained in this documentation are supplied for information purposes only and cannot be deemed as binding on the Company.



CONTENTS

TRANSFORMER FUNCTIONS AND TYPES

Why use a transformer?	2
How transformers work	2

FUNCTIONS

Insulation	3
Change of voltage	4
Secondary functions	5

TRANSFORMER TYPES

By insulation level	6
Standard insulation	6
Improved insulation	6
By application	7
Control transformers	7
Equipment transformers	7
Standard installation transformers	7
Special installation transformers (Medical)	7

STANDARDS

Master panel	8
--------------------	---

INSTALLING TRANSFORMERS

Series-parallel connection	10
Protection on the primary and secondary	11
Tapping points on the primary	12
No-load voltage – on-load voltage	13
Making current	15
Power: effect of $\cos \varphi$	16
Efficiency	17
Transformer losses	18
Temperature class	19
Instantaneous power	19
Derating according to the ambient temperature	20
Miscellaneous questions	22

SIZING OF CONTROL AND EQUIPMENT TRANSFORMERS

EXAMPLES OF APPLICATIONS WITH TRANSFORMERS

ELV circuits (reminder of safety voltages according to the humidity conditions)	24
1- Safety extra-low voltage (SELV)	24
2- Protective extra-low voltage (PELV)	24
3- Functional extra-low voltage (FELV)	24
Change of neutral earthing system	24

TRANSFORMER FUNCTIONS AND TYPES

WHY USE A TRANSFORMER?

Transformers are used to transfer electricity from a primary circuit to a secondary circuit via a magnetic field.

A secondary circuit can therefore be created with expected characteristics and functions, and 2 main functions in particular:

- Isolation
- Change of voltage

These 2 functions can be combined (eg: isolating transformer on 230 V primary/ 24 V secondary), although most applications only need the isolation function (eg: 230 V primary/230 V secondary).

HOW TRANSFORMERS WORK

Transformers consist of a winding called the primary and a winding called the secondary.

A variable speed generator connected to the primary winding causes a current circulating in the turns of this winding, which creates a magnetic field that varies over time.

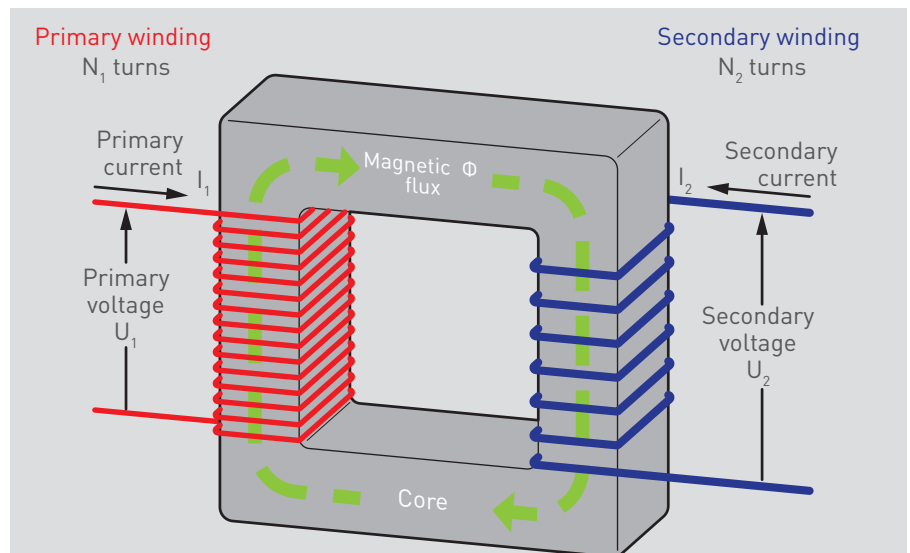

This magnetic field, channelled by a ferromagnetic core, passes through the secondary winding. Each turn in the secondary winding then creates a new induced voltage (back electromotive force).

This secondary circuit can then be used to supply another voltage and a given power. Electricity is therefore transferred from the primary circuit to the secondary circuit by means of magnetic energy, which allows this secondary circuit to be electrically "isolated".

Changes of voltage are linked to the number of turns in the primary and secondary windings.

Isolation is represented schematically by the space between the primary and secondary circuit, and in the diagram below, by the space between the windings and the magnetic body.

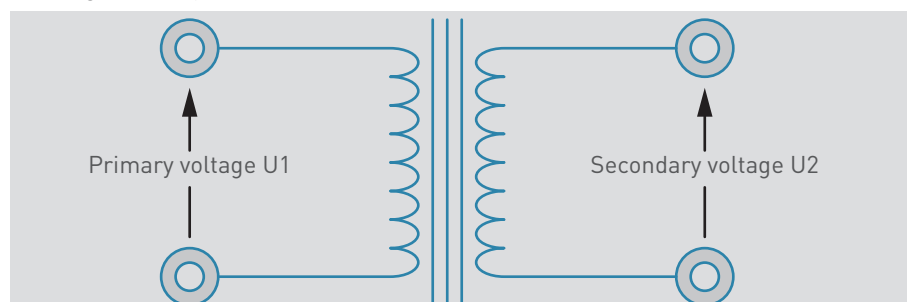

FUNCTIONS

Isolation

Isolation requires physical separation between the primary circuit and the secondary circuit, which is achieved by insulated components and/or distance in the air between conductive elements, and between conductive elements and exposed conductive parts.

This function can protect people against indirect contact.

- the electrical power made available in buildings always has one of its poles that is connected to earth (neutral). Hence, in TT system for example, if a phase accidentally touches accessible conductive parts (machine body), any contact with this metal part will offer a possible earth loop by passing through the body, and then becomes dangerous → The use of RCCBs or RCB0s is then mandatory.

Thanks to isolation of the secondary circuit, the same fault situation will not allow an earth loop, and therefore no difference in potential will be felt by the person: in this case the secondary circuit is said to be “floating”, and will not be dangerous, even with voltages higher than 50 V.

According to the standards, this ability to protect people without an additional device is only possible if it involves reinforced insulation or double insulation (see section “Transformer types”)

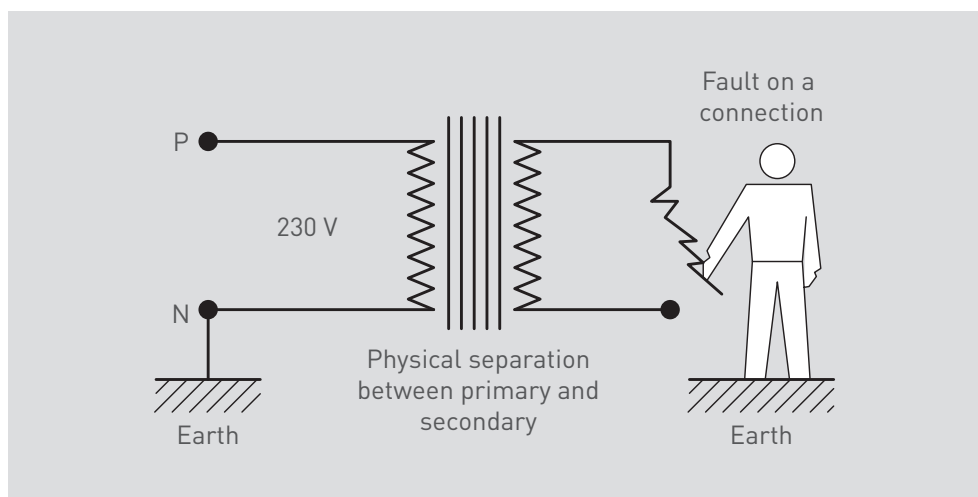

Change of voltage

The equation $U_2/U_1 = N_2/N_1$ defines the change of voltage obtained.

U_1 and U_2 are the primary and secondary voltages, N_1 and N_2 represent the number of turns in the primary and secondary.

This function can either adapt the installation voltage to the voltage permitted by the equipment (400 V → 230 V or vice versa, or even other voltages), and also lower the voltage to safe levels: in the latter case we talk about extra-low voltage (ELV: < 50 V AC).

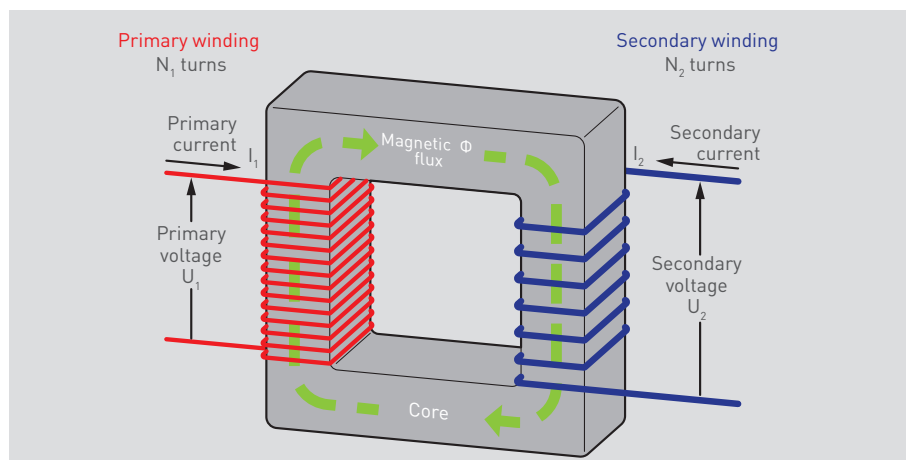

In the latter case of extra-low voltages, the transformer can directly protect people by ensuring contact with both secondary poles is safe.

According to the regulations, this ability is verified without additional equipment if the installation satisfies the requirements concerning Safety extra-low voltage (SELV: see page 25).

The combination of the isolation function and ELV offers a high level of safety for people.

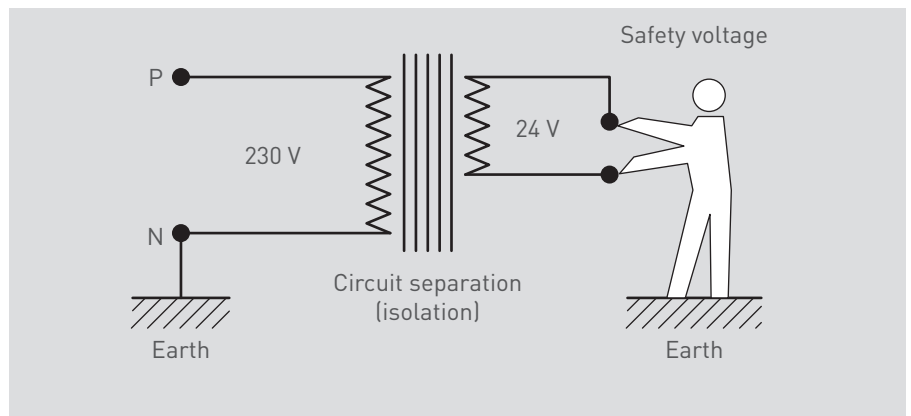

i The auto-transformer is the easiest way to change voltage, but it does not provide any safety because it does not incorporate any electrical isolation between the power supply circuit and load circuit (only 1 winding for the primary and secondary connection). It does however prove an economical solution if only the voltage needs to be changed.

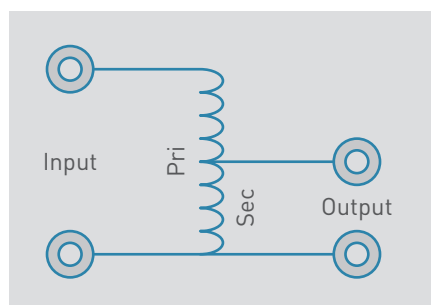

Secondary functions

FILTERING ELECTROMAGNETIC INTERFERENCE

A standard isolating transformer offers minimal ability to filter electromagnetic interference.

However, to increase this ability, it is possible to insert an electrostatic shield between the primary and secondary windings, that can be connected to earth.

Its efficacy depends on the primary/secondary capacitance, which itself depends on the transformer construction topology. The lower the capacitance is, the more effective the transformer will be in weakening propagation of interference between the primary and secondary.

Filtering interference has applications in large retail developments for example, in order to eliminate 3rd order harmonics emitted by fluorescent lighting.

Also in the medical sector, to isolate the main building from interference generated in other sectors: hydrotherapy, ionising radiation etc, and in industry, when there is a need to isolate sensitive sites, such as computer rooms, measurement laboratories, computer-controlled machines, etc.

TRANSFORMER TYPES

By insulation level

There are different insulation levels for transformers.

STANDARD INSULATION

This consists of separation between windings and between winding and earth with sufficient insulation thicknesses or distances to ensure compliance with minimum insulation requirements. A standard isolating transformer cannot claim to keep people safe without extra equipment.

This insulation is also called basic insulation.

IMPROVED INSULATION

There are 2 possible types:



■ Reinforced insulation

Consisting of increased insulation thickness (foil/air insulation), between the primary and secondary circuits.

■ Double insulation

Consisting of the basic insulation plus extra insulation. This is mainly used for the insulation between the primary and secondary via a metal conductive part => Eg: Basic insulation between the primary and metal conductive part and extra insulation between the metal conductive part and the secondary (the metal conductive part is often the magnetic body).

From the point of view of the standards, only transformers complying with this latter category can claim to protect people indirectly without additional devices.

	NAME	STANDARDS		SYMBOL
		NAME OF STANDARD	INSULATION TYPE	
STANDARD INSULATION	Isolating transformers Control transformers	IEC/EN 60076-11 IEC/EN 61558-2-2	Basic insulation	
IMPROVED INSULATION	Isolating transformers Safety transformer	IEC/EN 61558-2-4 /2-6/2-8/2-5/2-15	Reinforced insulation Basic insulation + extra insulation: double insulation	A bar "---" is added between the 2 circles 

By application

CONTROL TRANSFORMERS

These transformers comply with the requirements concerning control contactors, relays, etc. The minimum characteristics are covered by standard IEC/EN 61558-2-2, with for example a maximum voltage drop, the indication of the permissible instantaneous power.

For the Legrand range, these transformers comply with the "isolation" standards IEC/EN 61558-2-4 for secondaries higher than 50 V or "safety" type.

IEC/EN 61558-2-6 for secondaries lower than 50 V.

EQUIPMENT TRANSFORMERS

These transformers do not need to comply with "control" standard IEC/EN 61558-2-2, and are particularly suitable for fitting in a special enclosure, often physically connected to a device.

STANDARD INSTALLATION TRANSFORMERS:

These are simple isolating transformers. They comply with IEC/EN 60076-11.

This type of transformer is suitable for the requirements of changing voltage or neutral earthing systems that do not need reinforced insulation or double insulation. It is essential to add a device to protect people.

TRANSFORMERS FOR MEDICAL LOCATIONS:

These are transformers for separating specific circuits. In addition to complying with IEC/EN 61558-2-4, they also conform to EC/EN 61558-2-15 which notably requires limitation of the secondary/earth leakage current to 0.5 mA at no load, limitation of the inrush current, presence of an electrostatic shield, presence of elements for temperature monitoring.

STANDARDS

Transformers are subject to standardisation, and must therefore comply with the standards.

At present, a single document, IEC 61 558, examines the question from all angles and takes account of the majority of application scenarios.

DEVELOPMENTS IN THE STANDARDS

All the publications have now been gathered into a single document: IEC 61 558. This contains two sections, making it easier to use.

Section 1 for the general rules. Section 2 which gives instructions to users so they can comply with regulatory constraints or requirements of the standards. Section 2 is itself divided into several parts, at least three of which are relevant to us:

- Part 2.2: Control transformers.
- Part 2.4: Isolating transformers for general use.
- Part 2.6: Safety transformers for general use.
- Part 2.15: Transformers for medical locations.

Transformer standards are identified by symbols, which are also standardised.

OTHER STANDARDS GOVERNING TRANSFORMERS

- **IEC 60 076-11**
for dry-type transformers.
- **UL 5085**
for transformers for general use, including control transformers.
- **CSA C 22.2 no. 66**
same as above.
- **UL 60 950**
CAN/CSA C 22.2 no. 60 950.00
IEC 60 950/EN 60 950
which specify the rules for dealing with information technology equipment.
- **IEC 1204/EN 61 204**
which explains the performance characteristics and safety requirements for low-voltage power supply devices with DC output.
- **EN 61 131.2**
governs programmable controllers, equipment test requirements and especially the power supply values, in AC and DC, of CPUs.

TRANSFORMER STANDARDS

There are various standards which cover transformers. The applicable standard is determined by the transformer function(s). These functions are as follows:

■ Change of voltage:



Isolating transformer (basic insulation between primary and secondary).



Autotransformer (no insulation between primary and secondary).

■ Control circuit power supply:



Control transformer (basic insulation between primary and secondary).

■ Protection against electric shock

Protection against direct contact and indirect contact:



Safety transformers (reinforced insulation between primary and secondary, no-load voltage < 50 V).

Protection against indirect contact:



Isolating transformers (reinforced insulation between primary and secondary).



Isolating transformers for medical locations.

Transformer functions can either be determined by the equipment designer or be imposed by the installation instructions or equipment standard. The range of standards applicable to transformers is summarised in the table opposite.

■ Definitions:

- Electric shock: physiopathological effect resulting from current passing through the human body.
- Direct contact: contact between people and live parts.
- Indirect contact: contact between people and conductive parts that have accidentally become live as a result of an insulation fault.

In short:

Main transformers used for protection against electric shock	Isolating transformers (single-phase and three-phase) EN 61 558-2-4
	Safety transformers (single-phase and three-phase) EN 61 558-2-6
Main transformers used for functional reasons	Control transformers EN 61 558-2-2
	Transformers for medical locations EN 61 558-2-15
	Isolating transformers EN 60 076-11

INSTALLING TRANSFORMERS

Series-parallel connection

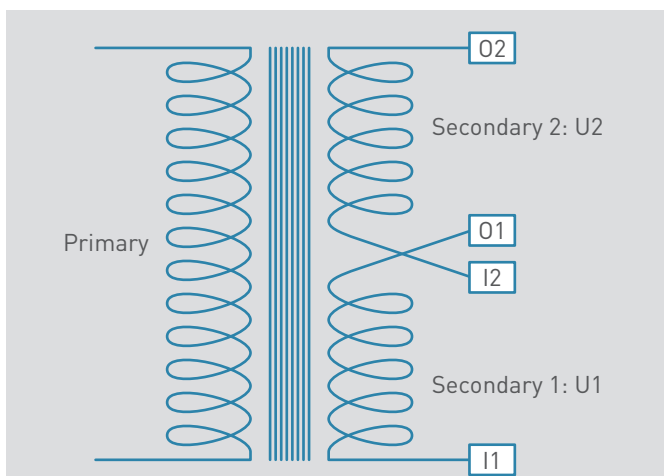

The secondary voltages U_1 and U_2 should be the same for parallel connection.

SERIES CONNECTION

Link between terminals E2 and S1, operating voltage between terminals E1 and S2:

The voltage obtained is the sum of the voltages of both windings, the nominal power stays the same.

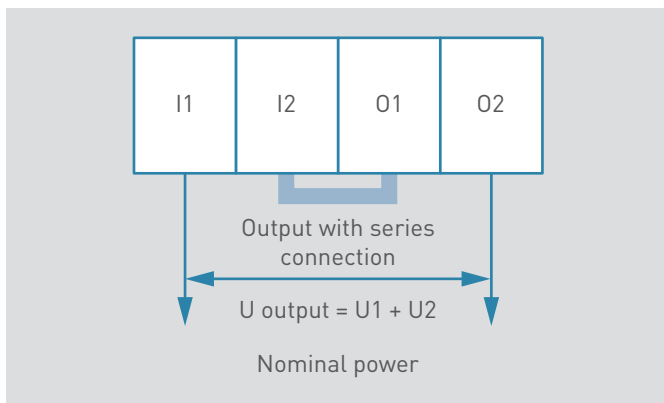

PARALLEL CONNECTION

Link between terminals E1 and E2 and link between terminals S1 and S2, operating voltage between terminals E1 and S2:

The voltage obtained is the voltage on each winding, the nominal power stays the same.

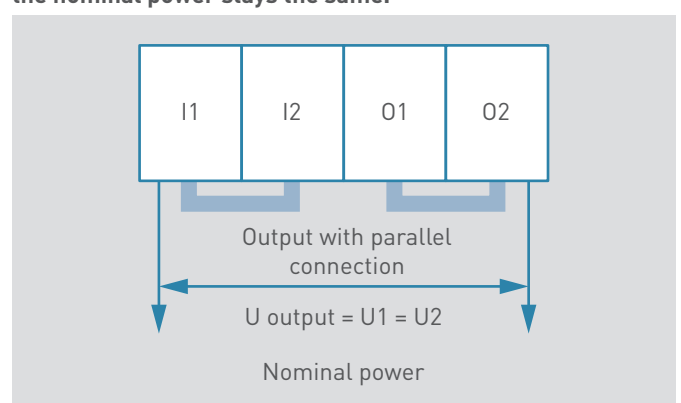

Some transformers are supplied with an extra link. This is provided for the requirements of certain installations that require a link between the secondary and the conductive part.



Caution, this link must not be fitted between the transformer primary terminals.

Transformer supply line protection

A transformer is a device that cannot generate overloads. Its supply line only needs protection against short-circuits. Short-circuit protection is mandatory for all installation scenarios and must be installed at the head of the line.

When a transformer is energised, the magnetic circuit may become saturated, depending on where the power supply sine wave is on energisation. This saturation causes significant overcurrents, that can reach as much as 25 times the nominal current, decreasing over 4 to 5 periods (approximately 10 ms).

To avoid any problem with the protection tripping, fit a delayed protection device on the primary, with either an aM fuse or D circuit breaker.

Transformer protection

In accordance with IEC/EN 61558, transformers must be protected on the secondary against overloads and short-circuits. As the standards do not impose particular requirements, the manufacturer can choose what protection device to use and where to place it. Legrand recommends protection on the secondary. The rating, type and location of the protection device is stated on the front of the equipment.

Working line protection (after transformer secondary)

This line must be protected against:

- Overloads: check that the protection rating chosen is the same or lower than the transformer secondary current
- Short-circuits: check that a short-circuit at the furthest point on the line will trip the protection device in less than 5 seconds (NF C 15-100, paragraph 434)

In cases where the transformer only supplies one working line, and provided that the calculations have demonstrated perfect compatibility, the transformer protection (on the secondary) and line protection can be combined. A single protection device thus performs both functions.

In cases where the transformer supplies several working lines, overloads and short-circuits must be calculated individually for each line.

INSTALLING TRANSFORMERS

Tapping points on the primary

Some transformers and power supplies have tapping points on the primary.

SCENARIO 1:

The incoming voltage at the transformer primary terminals is different from 230 V or 400 V: see the wiring diagram below.

SCENARIO 2:

The load power is lower than the nominal power. The voltage drop expected in the transformer is not therefore fully consumed and the voltage at the transformer secondary may then be a bit too high. In this case, proceed as if the input voltage at the primary terminals were 245 V (rather than 230 V) or 415 V (rather than 400 V) to decrease the working voltage.

SCENARIO 3:

The output current, especially at a high value, causes a voltage drop in the cables supplying the equipment. If the cables are long, this loss can prevent the equipment supplied from working properly. The working voltage should therefore be increased a little. To do this, proceed as if the input voltage at the secondary were 215 V (rather than 230 V) or 385 V (rather than 400 V).

In all 3 cases, the input voltage should be corrected in the transformer to adjust the secondary voltage.

Incoming voltage at the transformer primary

and

use of tapping points on the transformer primary terminals

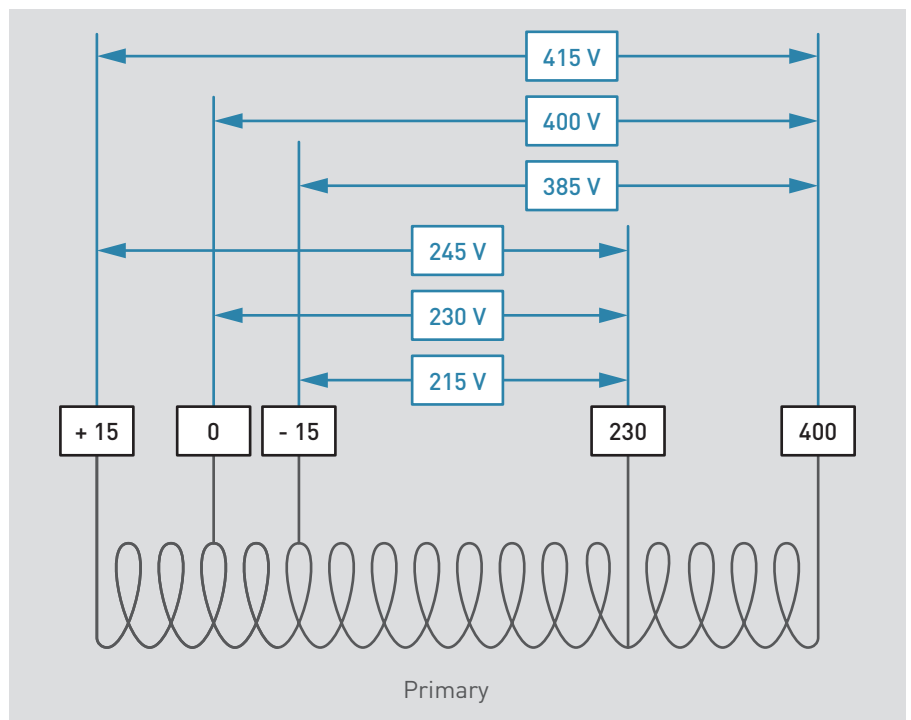

No-load voltage

This is the secondary voltage obtained when the transformer is supplied at the rated primary voltage and the rated frequency, without a secondary load.

When the transformer is brought on load, the current and resistance in the winding wires causes a voltage drop. This voltage drop marks the difference between the no-load voltage and the on-load voltage.

The on-load voltage corresponds to the voltage obtained when the transformer is loaded at its nominal rating. If the transformer is not fully loaded, the expected voltage drop is only partly consumed and the transformer on-load voltage will therefore be higher.



Note: For EN 60076-1 power transformers, the rated voltage stated on the transformer corresponds to the no-load voltage. For EN 61558 transformers, the rated voltage stated on the transformer corresponds to the on-load voltage.

A transformer is not a voltage regulator.

The voltage drop is expressed as a %.

Do not confuse this with U_{sc} !! The U_{sc} is used to define the I_{sc} short-circuit current value at the transformer primary. It is used to check compatibility of the line I_{sc} with the breaking capacity of the supply line protection device.

(I_{sc} at the transformer primary = I_p/U_{sc} – Example: nominal supply current in the 100 A transfo and $U_{sc} = 2\% \rightarrow I_{sc} = 5000$ A at the transformer primary).

Let's take the case of a transformer Cat. No. 0 427 87.

Its stated voltage drop for $\cos \phi 1$ is 10.7% (see technical characteristics table in the catalogue).

This means that if the primary voltage is indeed 230 V or 400 V and the transformer is loaded with 100% of the nominal power (100 VA in our example), we get:

On-load voltage 230 V (+/- standard tolerances)

No-load voltage: 230 V + 10.7% = 255 V

But if the transformer is only loaded with 50% of the nominal power (or 50 VA), the secondary voltage will not then be 230 V on load, but 242 V.

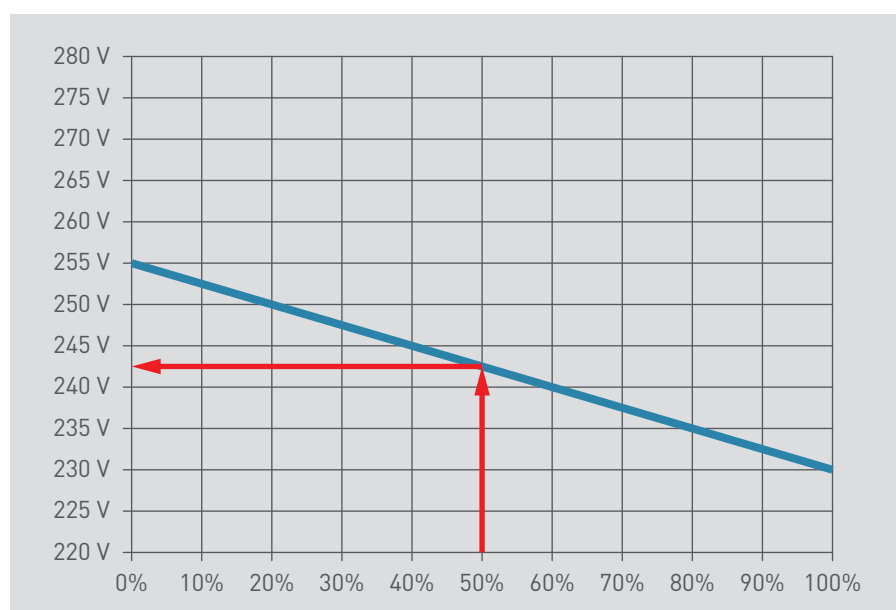

INSTALLING TRANSFORMERS

No-load voltage (continued)

If, in addition, the input voltage is not 230 V, but higher; for example power supply 245 V (the voltage delivered by the power grid may be $230\text{ V} + 10\% = 253\text{ V}$), the voltage should be increased accordingly at the secondary (blue line on the diagram opposite), which will give:

- 245 V at 100% of the nominal power
- 258 V at 50% of the nominal power
- 265 V at 20% of the nominal power
- 270 V at no-load

If use of the secondary voltage requires a more finely-tuned voltage (supplying relays for example), we recommend choosing a transformer with tapping points from the control and signalling transformer range or asking for a transformer configured to your exact requirements. In this case, we would replace the 0 427 87 with a 0 442 63.

With a 0 442 63 transfo for the same application as in the above example:

Supply voltage 245 V between the +15 V and 230 V terminals

0 442 63 →

- 230 V at 100% of the nominal power
- 240 V at 50% of the nominal power
- 247 V at 20% of the nominal power
- 251 V at no-load

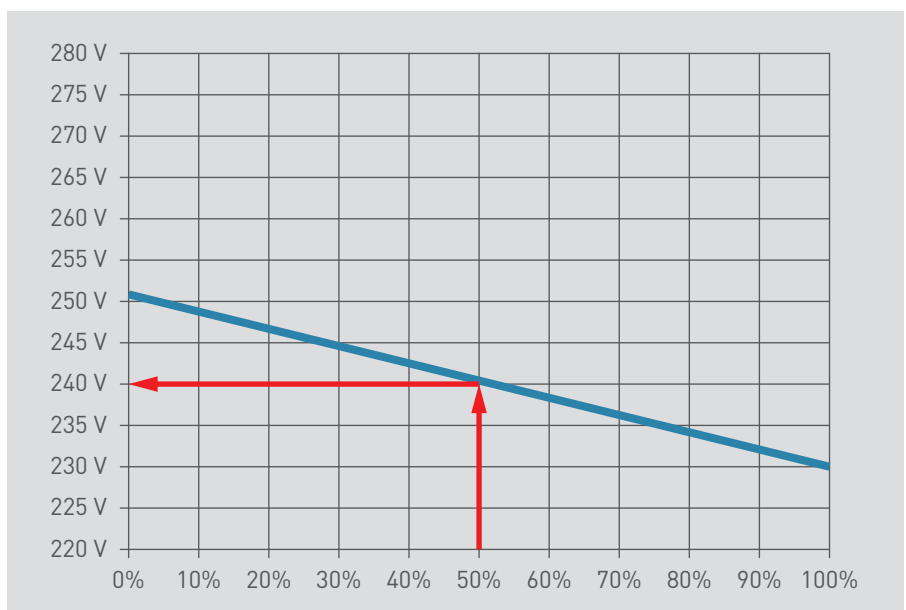
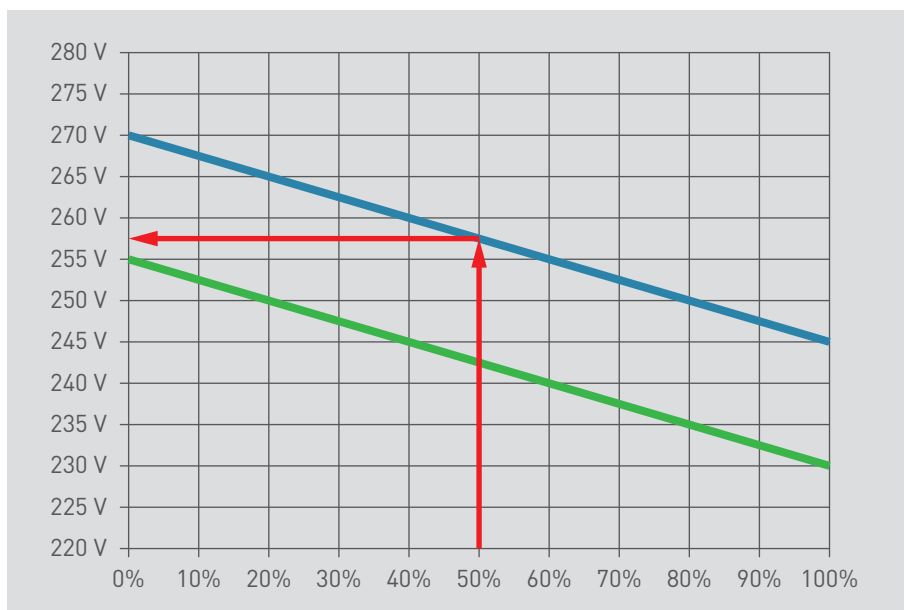

Making current

Powering up a transformer causes very rapid magnetisation of the magnetic circuit in the transformer. The magnetising current (or making current) can be very high (up to 25 In).

It is a transient current (a few milliseconds) that reaches its maximum if starting occurs when the voltage sine wave passes through "0". The remanent induction is then also at maximum. In this exact scenario, in a 1/2 period (10 ms), you should provide twice the nominal induction.

In conclusion, the value of the making currents is very random. It depends on the instant when power-up occurs.

Caution, powering up a transformer is likely to create interference on the primary supply and the secondary supply. On distribution networks and industrial networks, the making currents can for example create unwarranted trips and significant voltage surges.

Readout on start-up of a 142557 transformer (Single-phase 6.3 kVA) with 230 V power supply.
(Primary nominal current 28.5 A)

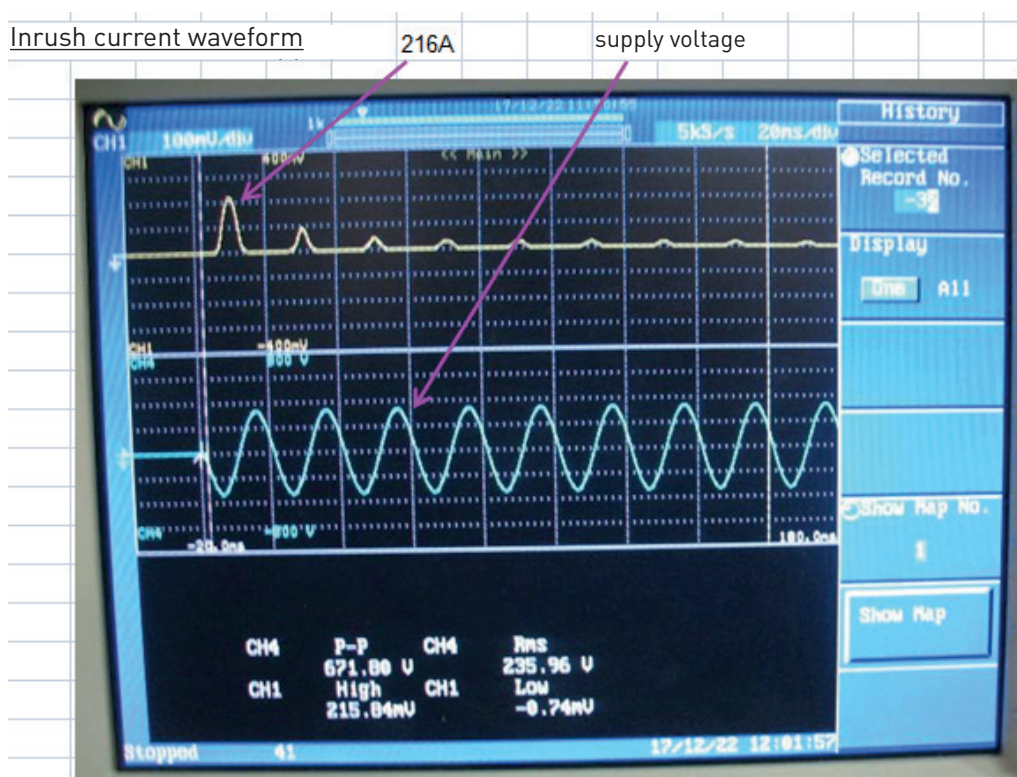

INSTALLING TRANSFORMERS

Power: effect of $\cos \phi$ (P in W)

The voltage and current are in the form of a sine wave. Depending on the equipment used, they can be time-shifted by an angle ϕ called the "phase shift angle".

This shift is due to the fact that the load consists of a resistive part (resistance), that corresponds to the circuit active power and a reactive part (reactance), that corresponds to the reactive power (inductive and/or capacitive component).

The voltage as a function of time is written:

$$u(t) = V \sin(\omega t)$$

The current is written:

$$i(t) = I \sin(\omega t + \phi) \text{ (}\phi \text{ phase shift in radians)}$$

The active power is written:

$$P(t) = u(t) \times i(t)$$

To get round this phase shift effect, the stated transformer power ratings are average P_s (nominal and permissible instantaneous), and are expressed in VA, not in W, with the equation:

$$\text{Apparent power } P \text{ in VA} = U \times I$$

$$\text{Active power } P \text{ in W} = U \times I \times \cos(\phi) \text{ in single-phase, and } = U \times I \times \sqrt{3} \cos \phi \text{ in three-phase}$$

The graphs opposite show what the active power becomes with different $\cos \phi$ for:

- a voltage of 12 V (12 V rms – peak 17 V) and
- a current of 7 A (7 A rms – peak 10 A).

If the use behind the transformer has a low $\cos \phi$, a transformer with a higher nominal power rating should be provided to correct this.

For example, fluorescent tubes without compensation usually have a $\cos \phi$ of 0.5. The tube power rating should be halved in order to define the transformer power rating.

A few examples of $\cos \phi$:

- Incandescent lighting $\cos \phi = 1$
- Fluorescent lighting with electronic ballast $\cos \phi = 1$
- Fluorescent tube lighting: with compensation $\cos \phi = 0.85$ and without compensation $\cos \phi = 0.5$
- Motors: normal operation $\cos \phi = 0.75$ to 0.92 and on start-up $\cos \phi = 0.3$ to 0.5 . If nothing is indicated, it is prudent to use $\cos \phi = 0.8$.

- Voltage
- Current
- Power
- Average power

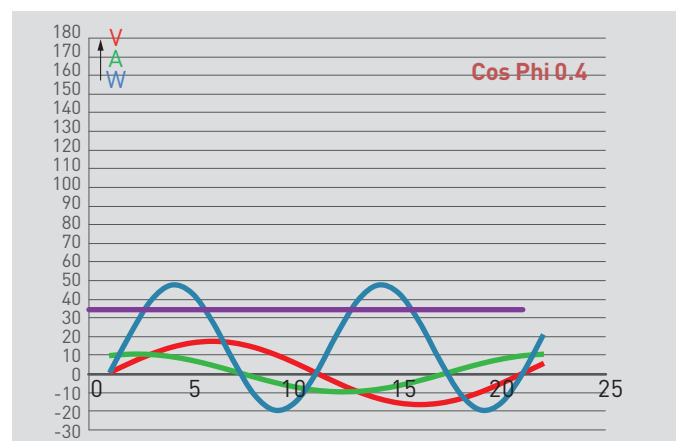
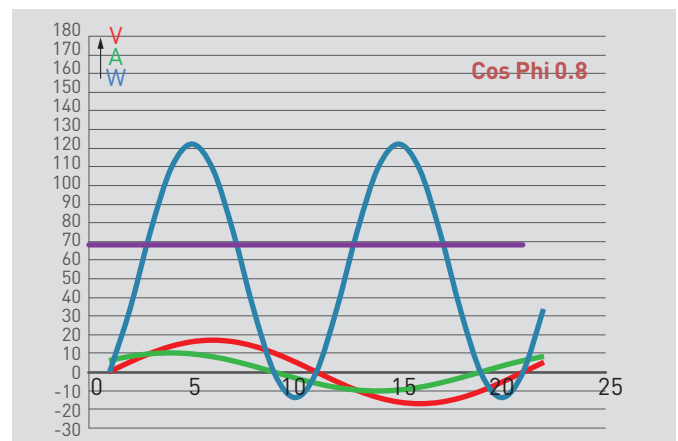

Efficiency

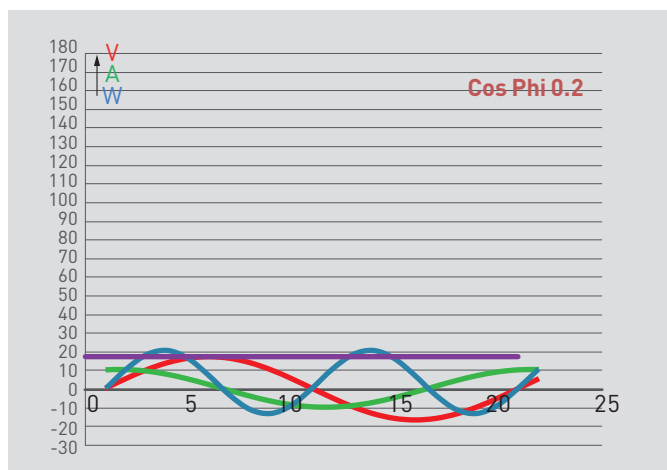
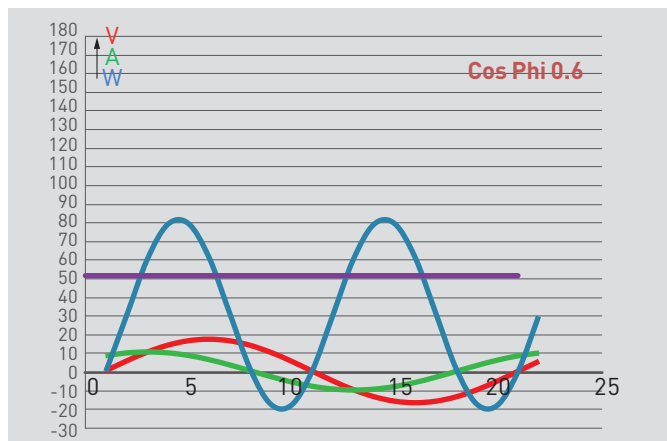
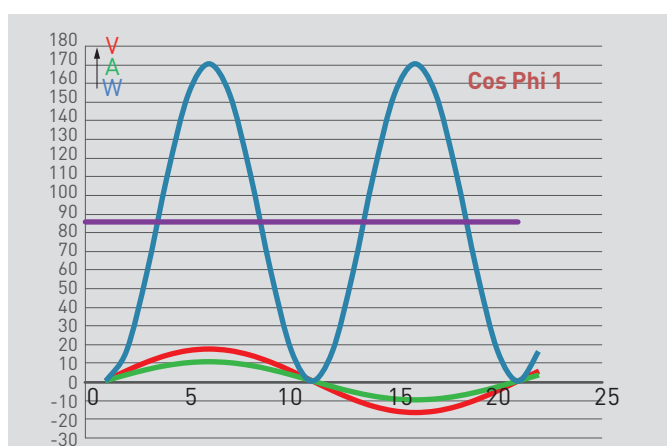

Efficiency can be used to characterise the proportion of losses compared to the power consumption

Efficiency is written:

$$\eta = \frac{\text{active } P \text{ supplied to the secondary}}{\text{total active } P \text{ absorbed}}$$

$$\eta = \frac{U_2 \times I_2 \times \cos \phi}{U_2 \times I_2 \times \cos \phi + \text{No-load loss} + \text{load loss}}$$

Hence, a transformer without much load will not be very efficient: the losses become significant (especially the no-load losses which remain constant) compared to the power consumed by the load.

This efficiency will also be degraded if this load is significantly phase-shifted ($\cos \phi < 1$).

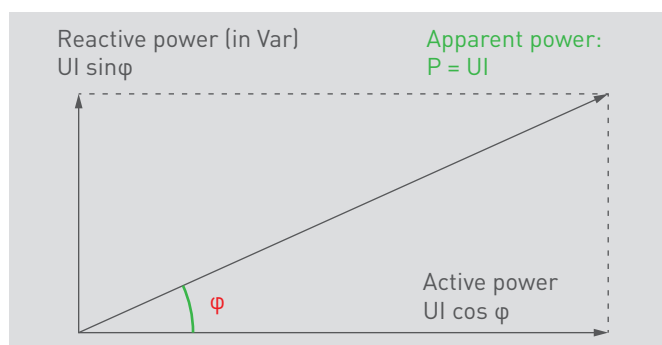

Transformer losses

A transformer's losses are made up of the no-load losses and load losses:

1 NO-LOAD LOSSES

Often called iron losses.

They occur in the ferromagnetic core. They depend on the frequency and the supply voltage.

They do not depend on the load at the transformer secondary.

Magnetisation of the laminations is accompanied by energy losses in the form of heat. There are two types:

- Hysteresis loss: magnetisation of the material is not totally reversible. The AC power supply creates a change of flux direction on each voltage half-wave, forcing the iron atoms to permanently rearrange themselves. This causes friction, which generates losses. These are hysteresis losses. They depend on the magnetising current and the material memory.
- Eddy current losses: are caused by induced currents, at right-angles to the electrically-conducting lamination, which try to cancel out a magnetic field passing through it. These induced currents increase with the size of the surface area crossed by this magnetic field. Eddy current losses depend on the square of the lamination thickness. This is why the transformer magnetic circuit is not formed from a block of steel, but created by a stack of laminations isolated from one another.

2 LOAD LOSSES

Load losses (or Joule effect losses) result from heat caused by the current flowing in the primary and secondary windings. These losses are proportional to the square of the transformer load.

They represent the energy dissipated in the form of heat caused by the current flowing in the primary winding and the secondary winding.

Since the winding resistance varies as a function of the temperature(*), the load losses are higher when the transformer has been working for several hours and the temperature has stabilised, compared to start-up.

In the LEGRAND catalogue, load losses are given at stabilised temperature at nominal load.

TOTAL LOSSES = NO-LOAD LOSSES + LOAD LOSSES

$$(*) : R_{T_1} = R_{T_0} (1 + (\alpha (T_1 - T_0)))$$

R_{T_1} is the winding resistance at temperature T_1

R_{T_0} is the winding resistance at temperature T_0

α is the temperature coefficient. This depends on the material used.

(For copper, $\alpha = 3.92927308 \times 10^{-3} \text{K}^{-1}$ at $T_{\text{ambient}} 20^\circ\text{C}$, for aluminium, $\alpha = 3.90625 \times 10^{-3} \text{K}^{-1}$ at $T_{\text{ambient}} 20^\circ\text{C}$)

Temperature class

A transformer's temperature class indicates that in normal use, at an ambient temperature of 25°C (if no ambient temperature is specified, or at the ambient temperature indicated by the manufacturer if displayed on the product), the transformer windings will not exceed the following temperatures:

Class B: 130°C

Class F: 155°C

Class H: 180°C

Maximum instantaneous power (MIP)

A transformer's maximum instantaneous power is a "peak" power that the transformer is capable of providing for a very brief time (from a few ms to a few seconds).

This characteristic is important when it comes to sizing the transformer, as it must be sufficient to cope with inrush current from certain inductive loads.

(See sizing on page 24)

Derating according to ambient temperature

When the ambient temperature increases, it is sometimes necessary to reduce the transformer working power to comply with its temperature class (see "Temperature class" section).

EQUIPMENT TRANSFORMERS

- **Power derating according to ambient temperature**
(conforming to the class, not conforming to EN 61558)

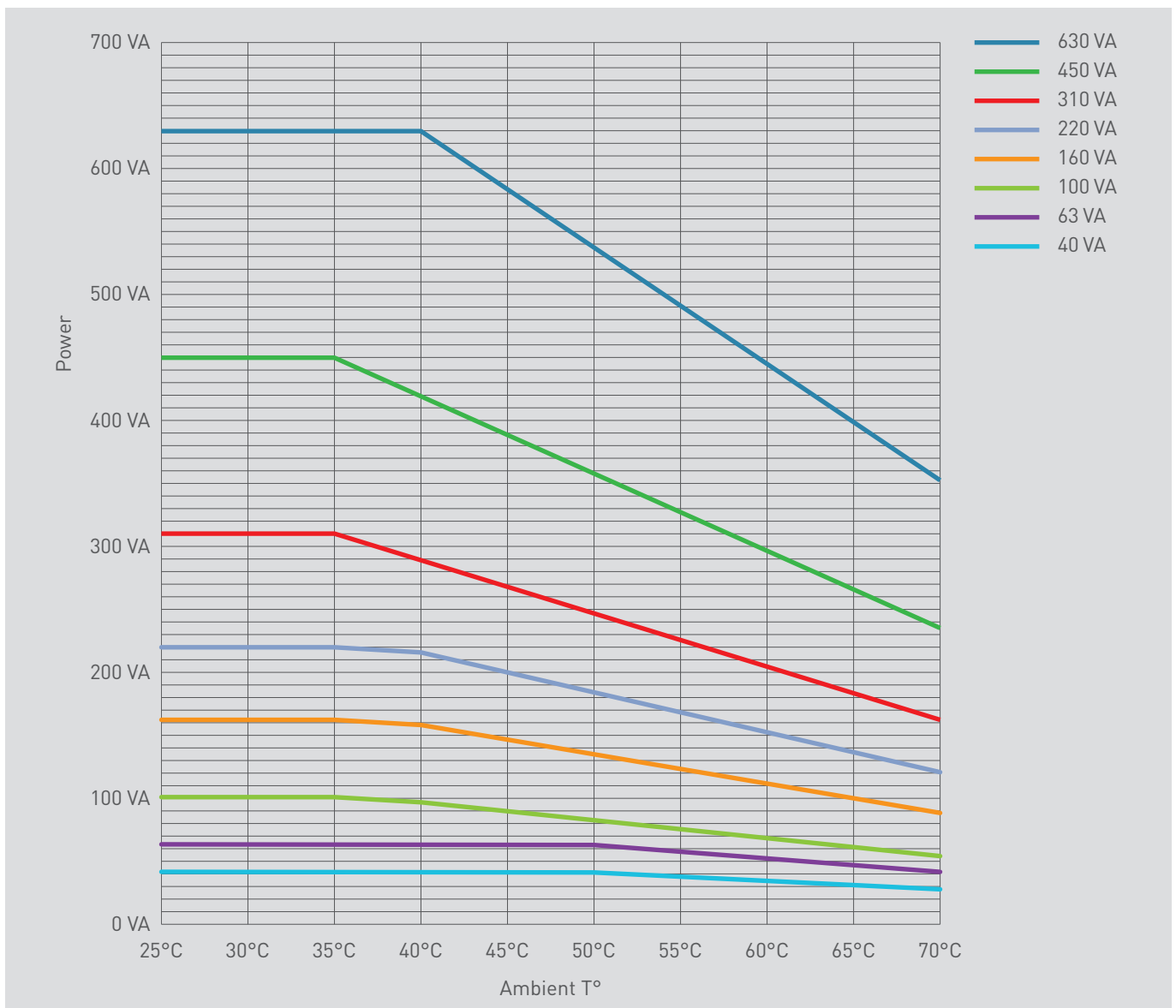

CONTROL AND SIGNALLING TRANSFORMERS

■ Power derating according to ambient temperature (conforming to the class, not conforming to EN 61558)

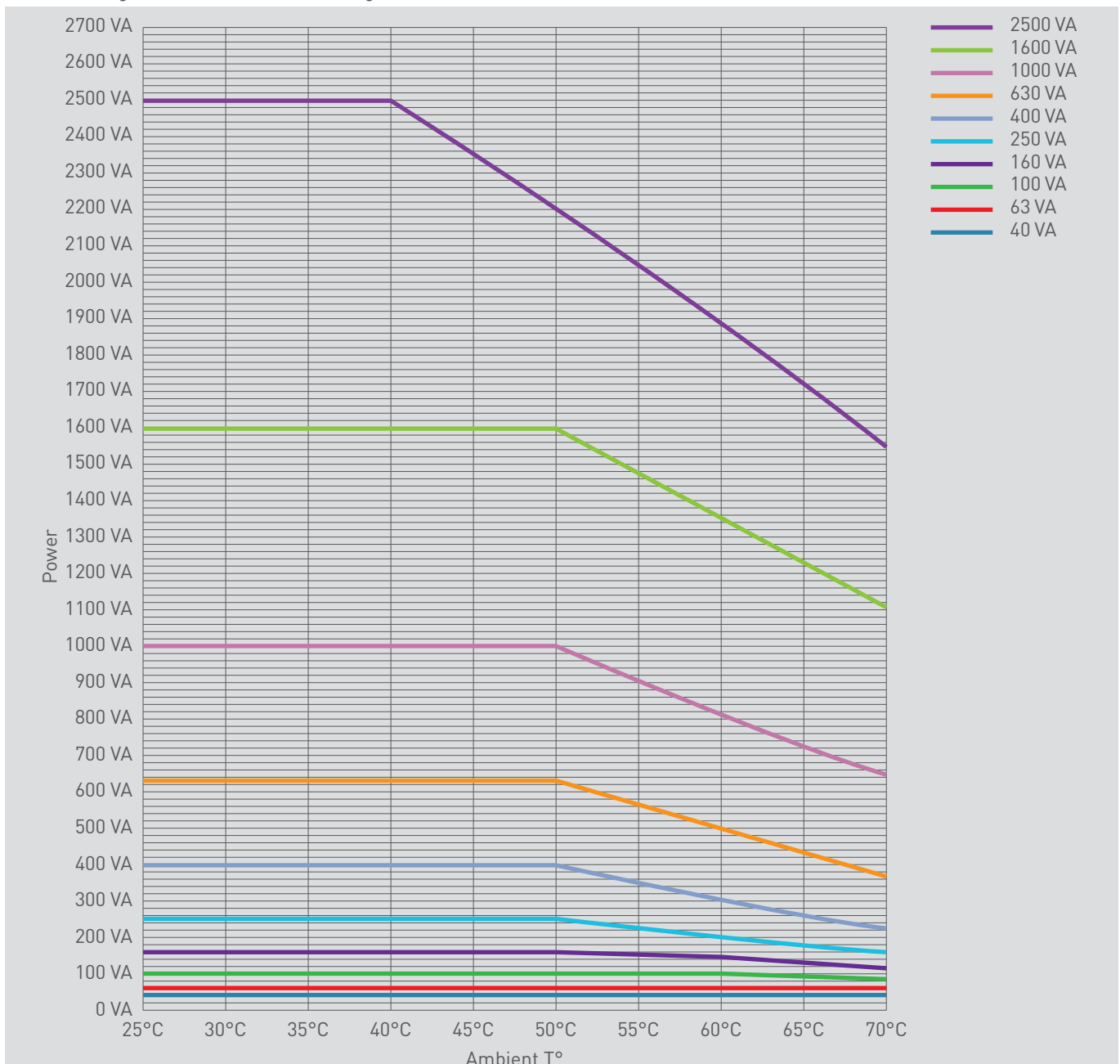

MISCELLANEOUS QUESTIONS

■ Sometimes no-load voltage is detected between the conductive part and neutral:

This may be a simple capacitive voltage: on trying to connect a load, the voltage collapses immediately.

It may be due to contamination of the conductive part. In this case, a measurement elsewhere than on the transformer between the conductive part and neutral also indicates voltage. This means it is a problem with the installation.

■ Sometimes problems occur when connecting boilers.

In most cases, the problem is resolved by connecting the neutral to the conductive part.

However, not all boilers have the same installation instructions, so it is essential to refer to the boiler manufacturer's instructions for use.

SIZING THE TRANSFORMER (CONTROL)

Every circuit needs a specific transformer power rating: this is sizing.

In the case of Control transformers, it is not enough to add up the power ratings of the load circuits. It is also necessary to take account of the maximum instantaneous power, which should be sufficient to take on the inrush power of the loads (essentially contactor coils, but also various motors or actuators).

For equipment including automation devices, the appropriate transformer should primarily be selected on the basis of 2 parameters:

- The maximum power needed at a given moment (inrush power)
- The Cos ϕ (see page 16 Power: effect of cos ϕ)

In addition, it should be necessary to confirm your choice with one of the following parameters:

- Permanent power
- Voltage drop (see page 13 No-load voltage)
- Ambient temperature (see page 19)

To determine the inrush power, we have agreed the following factors:

- Two inrushes cannot happen at the same time
- The power factor cos ϕ is 0.5
- 80% maximum of devices are supplied at the same time.

Empirically and to simplify matters, this power is calculated using the following equation:

$$P_{inrush} = 0.8 \times (\Sigma P_m + \Sigma P_v + P_a)$$

ΣP_m : sum of all the contactor holding powers

ΣP_v : sum of all the indicator powers

P_a : inrush power of the largest contactor

Example: A machine-tools control enclosure containing:

- 10 contactors for 4 kW motors, with 8 VA holding power
- 4 contactors for 18.5 kW motors, with 20 VA holding power
- 1 contactor for 45 kW motors, with 20 VA holding power, 250 VA inrush power at cos ϕ 0.5
- 12 remote control relays, with 4 VA holding power
- 45 LED indicators, with 1 VA consumption

This gives the following calculations:

$$\Sigma P_m = 10 \times 8 \text{ VA} = 80 \text{ VA}$$

$$4 \times 20 \text{ VA} = 80 \text{ VA}$$

$$1 \times 20 \text{ VA} = 20 \text{ VA}$$

$$12 \times 4 \text{ VA} = 48 \text{ VA}$$

$$228 \text{ VA}$$

$$\Sigma P_v = 45 \times 1 \text{ VA} = 45 \text{ VA}$$

$$P_a = 250 \text{ VA}$$

$$P_{inrush} = 0.8 [228 + 45 + 250] = 418 \text{ VA at cos } \phi \text{ 0.5}$$

For control transformers, simply read the size from the table below:

RATED POWER (VA)	M.I.P AT COS ϕ =								
	0.2	0.3	0.4	0.5	0.6	0.7	0.8	0.9	1
40	69	63	58	55	52	50	49	49	58
63	120	110	98	90	85	81	78	78	89
100	210	180	170	150	140	140	130	130	150
160	390	340	300	270	250	230	220	220	230
250	540	490	450	420	400	380	370	370	440
400	1900	1400	1200	980	800	800	700	600	600
630	2200	1700	1400	1000	1000	900	800	800	700
1000	3400	2800	2300	2000	1800	1600	1500	1400	1300
1600	14,300	12,000	10,300	9100	8200	7500	7000	6600	6800













EXAMPLES OF APPLICATIONS WITH TRANSFORMERS

ELV circuits

The ELV limits are defined in the regulations:

in AC: $U \leq 50 \text{ V}$

in DC: $U \leq 120 \text{ V}$

VOLTAGE RANGE	POWER SUPPLY	EARTHING	DISCONNECTION AND SHORT-CIRCUIT PROTECTION:	PROTECTION AGAINST INDIRECT CONTACT	PROTECTION AGAINST DIRECT CONTACT	RECEIVERS	WHEN SUBMERGED
SELV (Safety)	Safety transformer IEC/EN 61558-2-6 	PROHIBITED	Of all live conductors 	NO if $U \leq 25 \text{ VAC}$ (or 60 VDC) YES if $U > 25 \text{ VAC}$ (or 60 VDC)	NO if $U \leq 25 \text{ VAC}$ (or 60 VDC) YES if $U > 25 \text{ VAC}$ (or 60 VDC)		- $U < 12 \text{ V}$ (mandatory) - current source relocated outside volumes 0, 1 and 2 in bathrooms - protection against direct contact must always be guaranteed
PELV (Protection)	Safety transformer IEC/EN 61558-2-6 	Live conductor connected to earth 	Of all live conductors 	NO if $U \leq 12 \text{ VAC}$ (or 30 VDC) YES if $U > 12 \text{ VAC}$ (or 30 VDC)	NO if $U \leq 12 \text{ VAC}$ (or 30 VDC) YES if $U > 12 \text{ VAC}$ (or 30 VDC)		USE PROHIBITED
FELV (Functional)	Transformer of indeterminate origin 	Live conductor connected to earth 	Of all live conductors  	YES (RCD)	YES (IP 2x devices)		USE PROHIBITED

Change of neutral earthing system

Example of changing from an IT system without neutral \rightarrow TN-S with creation of neutral.

Standard system diagram of an island with three-phase TN-S system (can be applied to a single-phase system).

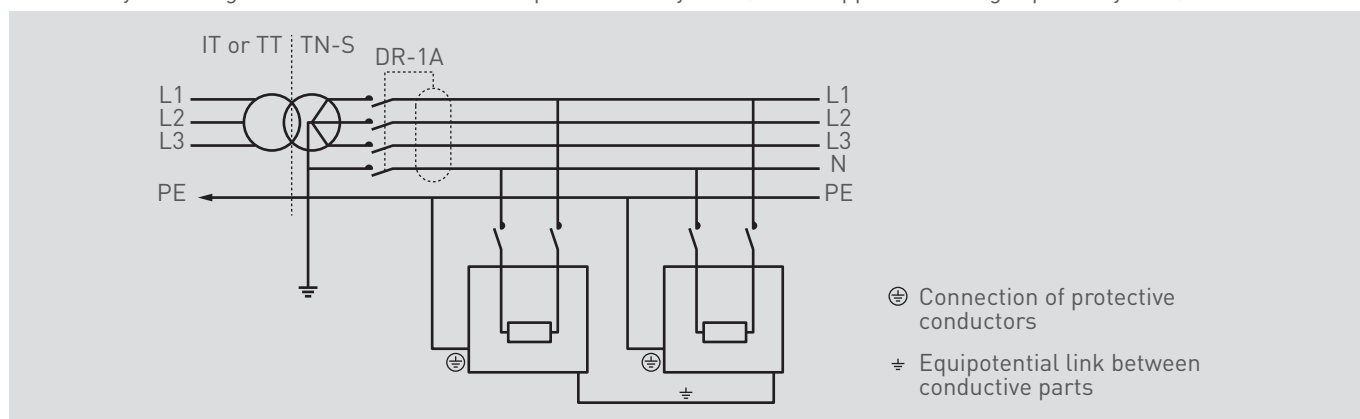

To know more,
check [export.legrand.com](https://www.export.legrand.com)



All technical data of the products inside this workshop specifications book are available on : <https://www.export.legrand.com/en>

>Click on >DOCUMENTATION & SOFTWARE

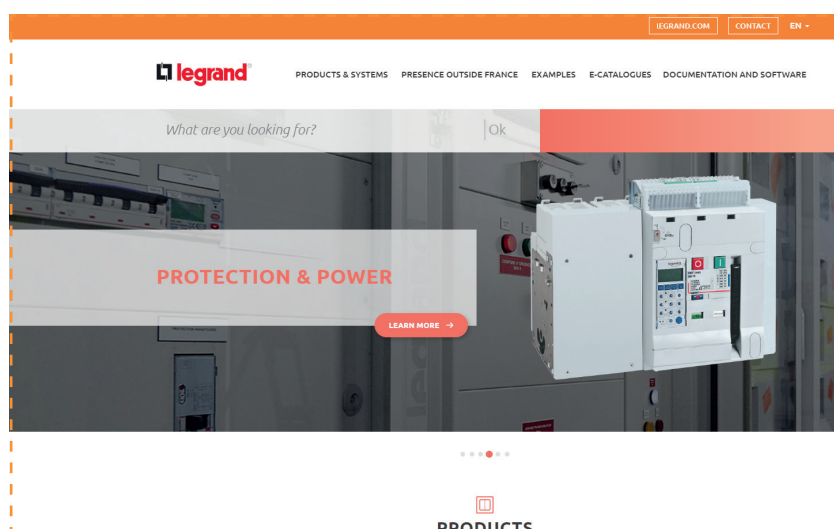

>Documentation

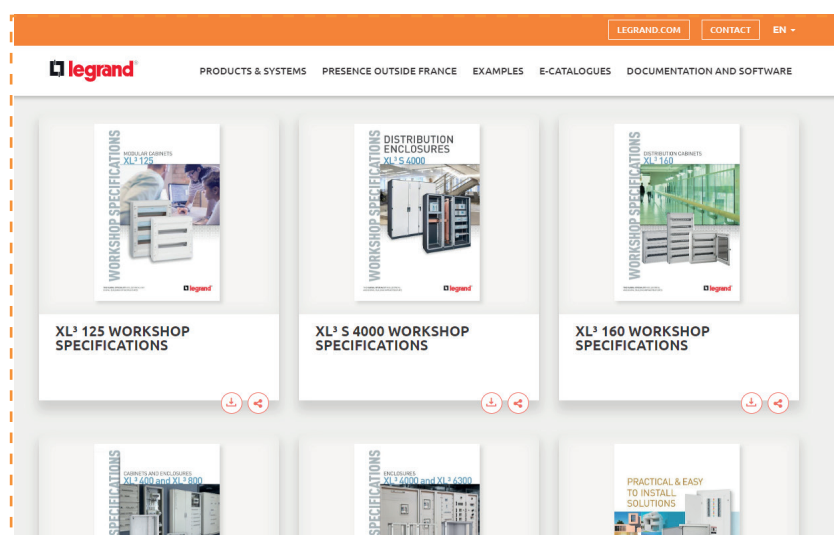



FOLLOW US ON

@ www.legrand.com

 www.youtube.com/legrand

 twitter.com/legrand_news



Head office
and International Department
87045 Limoges Cedex - France
Tel: + 33 (0) 5 55 06 87 87
Fax: + 33 (0) 5 55 06 74 55